

1 / 10 SCALE RC 4WD HIGH PERFORMANCE DRIFT CAR

MS-01D VIP II

1 / 10 DRIFT CHASSIS KIT

MS-01D VIP II (CS spec)

ON ROAD USE ONLY
FULL BALL BEARINGS

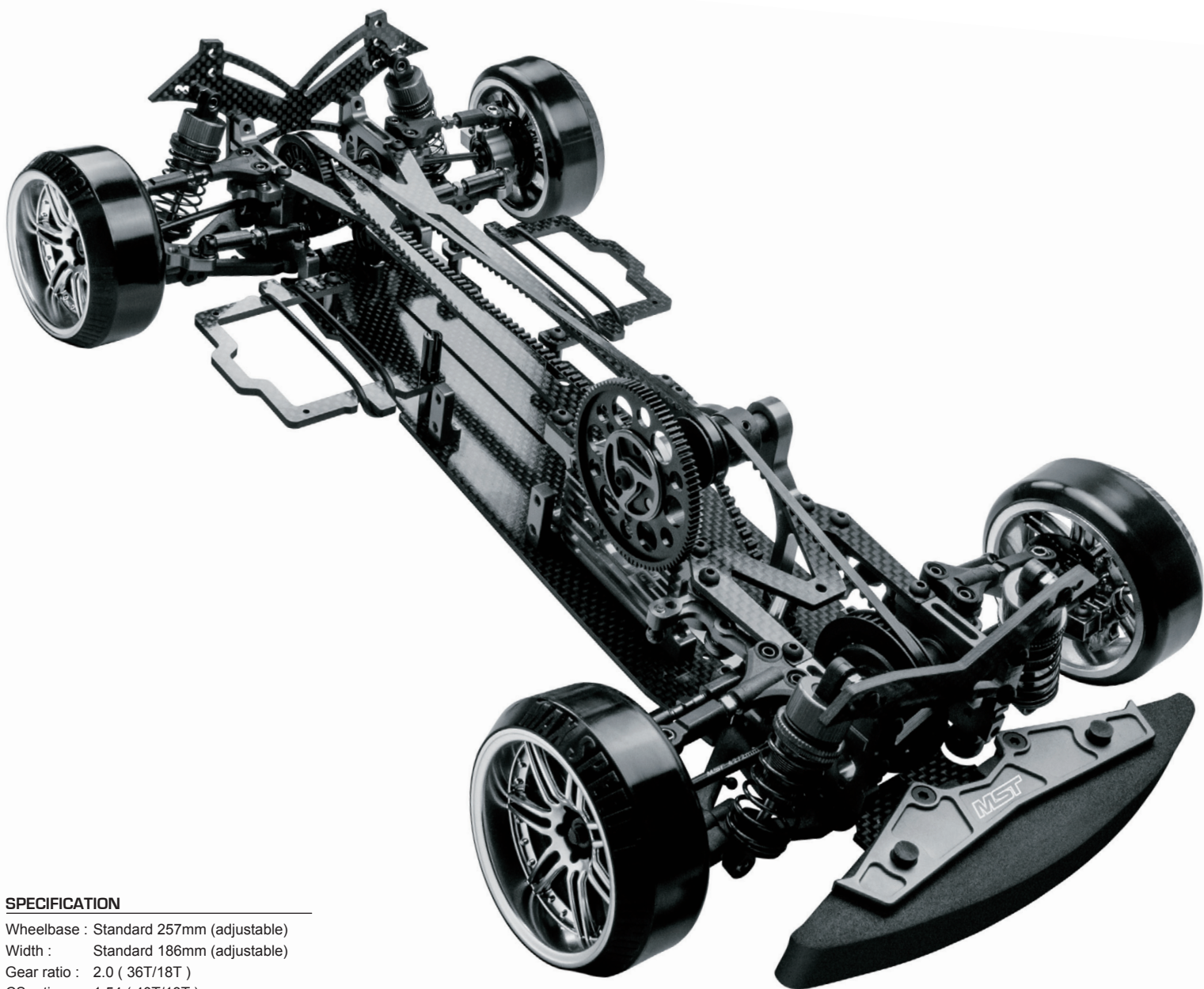

SPECIFICATION

Wheelbase : Standard 257mm (adjustable)
Width : Standard 186mm (adjustable)
Gear ratio : 2.0 (36T/18T)
CS ratio : 1.54 (40T/13T)
Caster : 4, 7, 10, 14 degrees variableness
Camber : 0 to -12 degrees

※ Specifications are subject to change without notice.

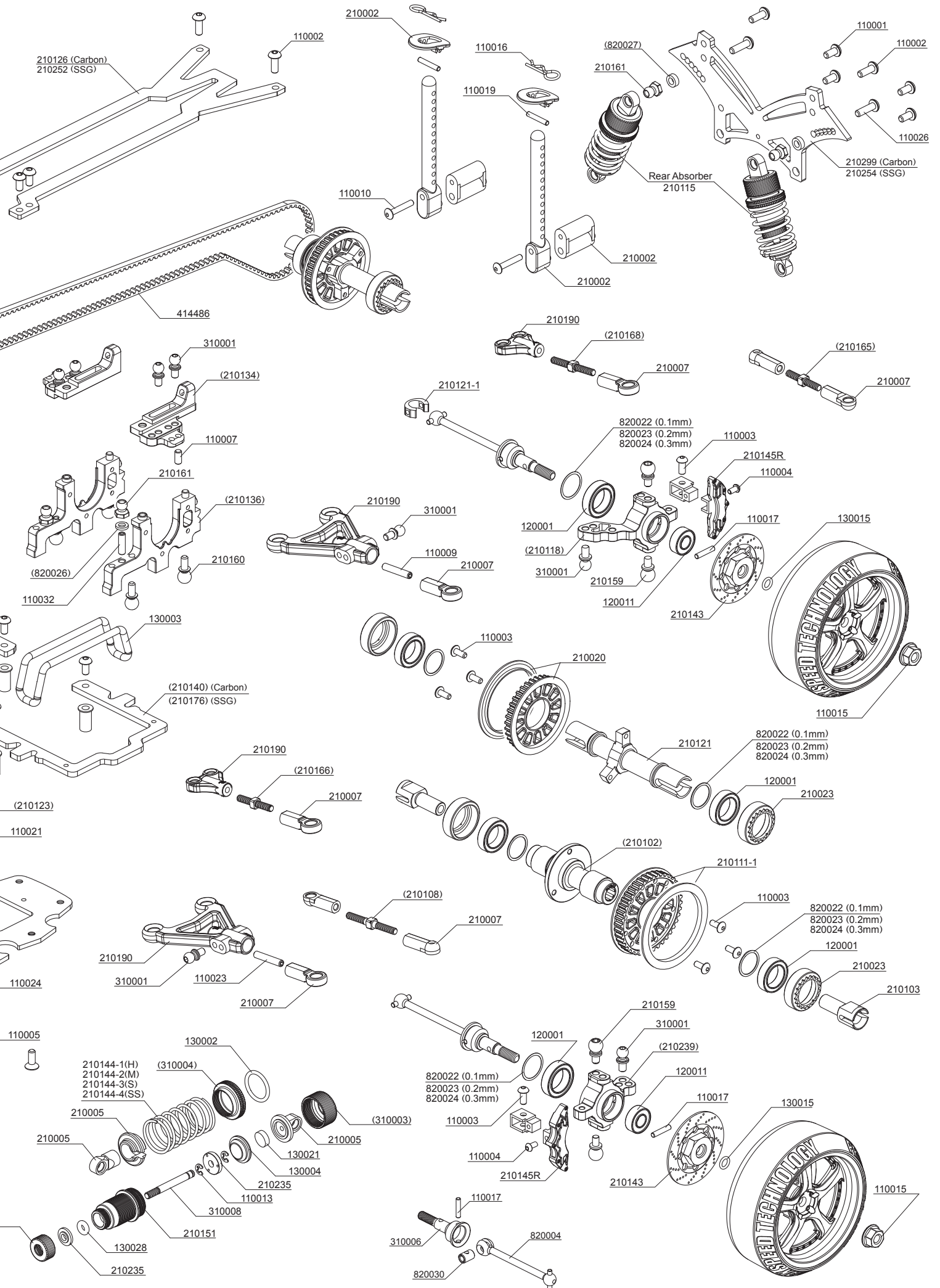

PARTS

210110 ×1set
防傾桿組
Stabilizer parts

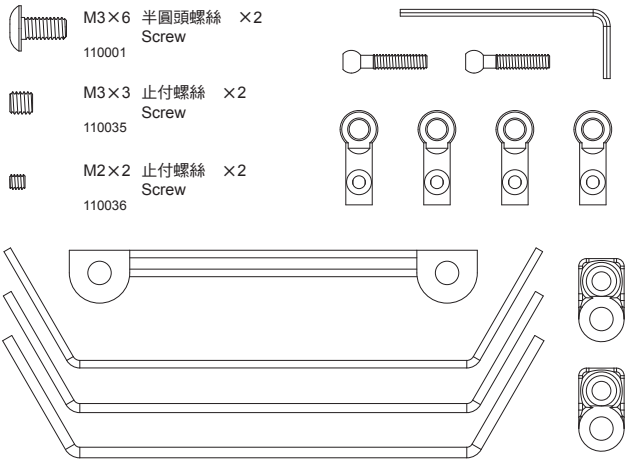

210002 ×1
C 部品
C parts

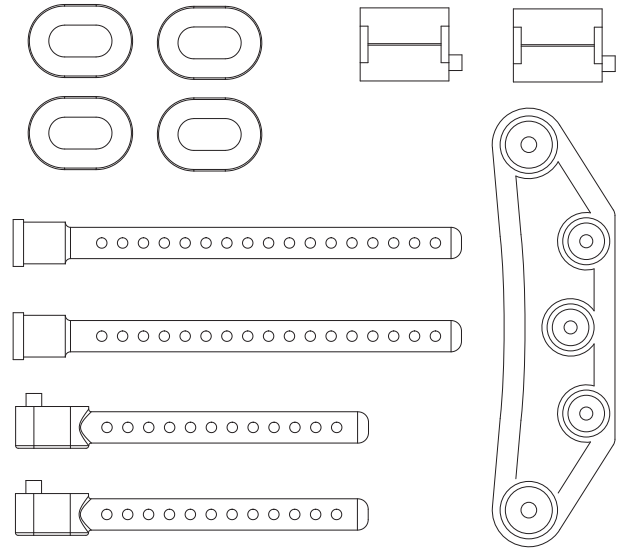

210111 ×1set
反胎用零件
Counter steering parts

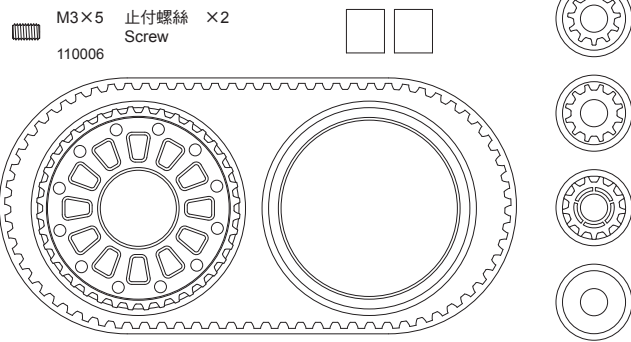

210020 ×1
皮帶齒18-36

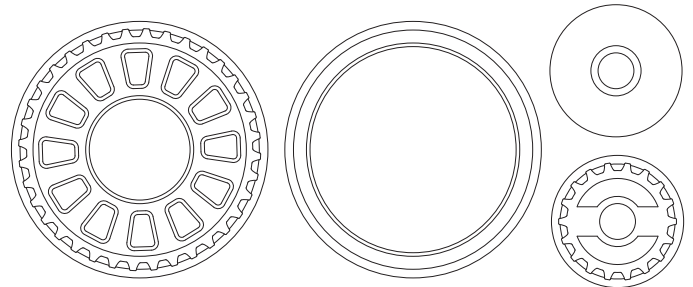

MS/FS 碳纖維電池座
MS/FS Carbon battery holder
210140R (red / 紅) /
210140S (silver / 銀)

MS/FS 碳纖維電池座 (SSG)
MS/FS Carbon battery holder (SSG)
210176R (red / 紅) /
210176S (silver / 銀)

鋁合金天線管座(通用型) ×1
Alum. antenna pipe mount (generalized)
210206

轉向支柱 ×4
Alum. steering post
210183R (red / 紅) /
210183S (silver / 銀)

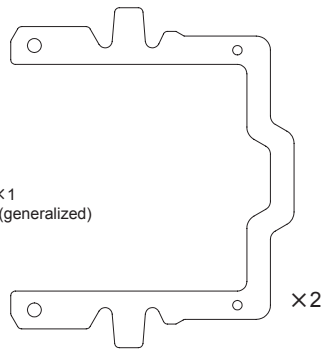

210007 ×2
H 部品
H parts

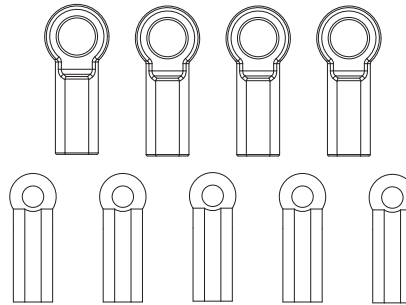

210023 ×2
皮帶調整環
Pulley Retainer

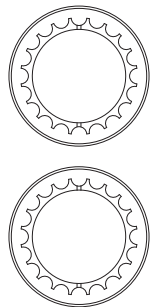

820002R (red / 紅) / 820002S (silver / 銀) ×1set
鋁合金伺服緩衝器
Alum. servo saver

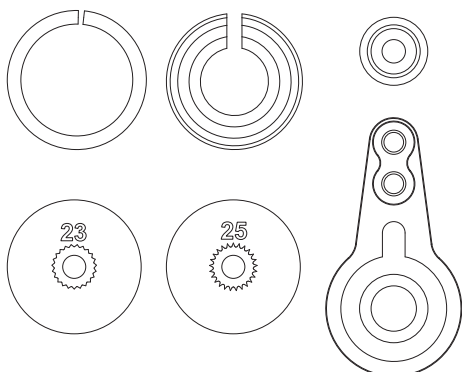

210145R (red / 紅) ×1set
煞車卡鉗(電鍍紅) (4)
Brake calipers (red) (4)

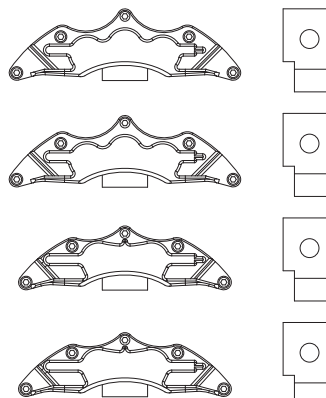

210190 ×4
強化擺臂組
Reinforced suspension arm set

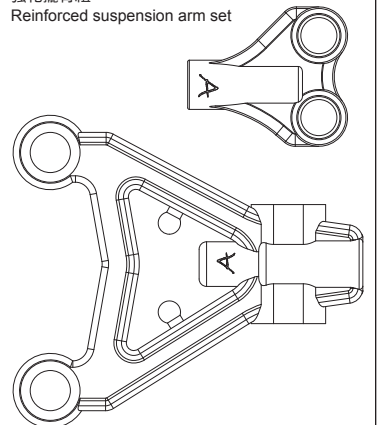

PARTS



皮帶 - 228 ×1
Drive belt - 228
414228

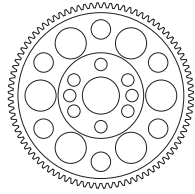

大齒盤 88T-48P ×1
Spur gear 88T-48P
210013

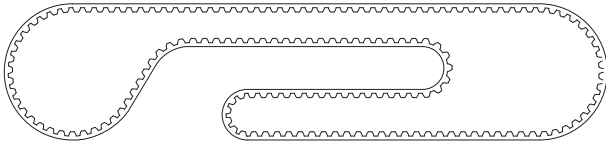

皮帶 - 486 ×1
Drive belt - 486
414486

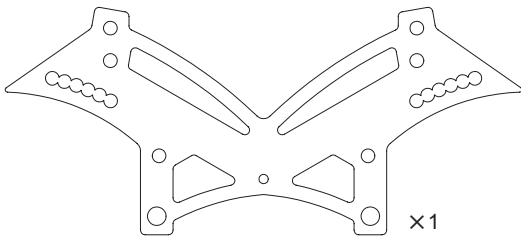

碳纖維後避震板 2.5
Carbon rear damper stay 2.5
210299

碳纖維後避震板 2.5 (SSG)
Carbon rear damper stay 2.5 (SSG)
210254

碳纖維前避震板
Carbon front damper stay
210298

碳纖維前避震板 (SSG)
Carbon front damper stay (SSG)
210303

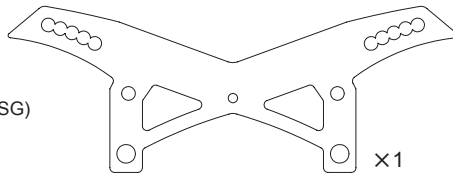

碳纖維後二樓板
Carbon rear upper deck
210126

碳纖維後二樓板 (SSG)
Carbon rear upper deck (SSG)
210252

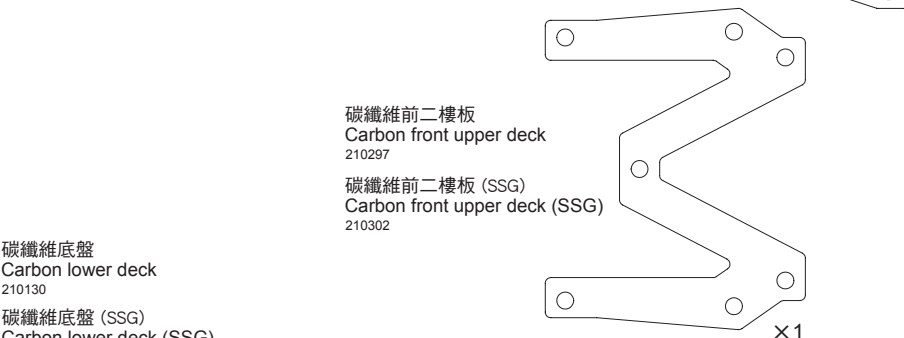

碳纖維前二樓板
Carbon front upper deck
210297

碳纖維前二樓板 (SSG)
Carbon front upper deck (SSG)
210302

碳纖維底盤
Carbon lower deck
210130

碳纖維底盤 (SSG)
Carbon lower deck (SSG)
210250

齒比表 Gear Ratio		
大齒盤 Spur Gear	馬達齒 Pinion Gear	齒輪比 Gear Ratio
88 (210003) (OP.148088)	24	7.33
	25	7.04
	26	6.77
	27	6.52
	28	6.29
89 (OP.148089)	23	7.74
	24	7.42
	25	7.12
	26	6.85
	27	6.59
90 (OP.148090)	22	8.18
	23	7.83
	24	7.50
	25	7.20
91 (OP.148091)	26	6.92
	21	8.67
	22	8.27
	23	7.91
	24	7.58
92 (OP.148092)	25	7.28
	20	9.20
	21	8.76
	22	8.36
	23	8.00
24	7.67	

210115R (red / 紅) / 210115S (silver / 銀) ×1set
鋁合金避震器組。
Alum. damper set

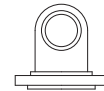

避震器上球座 ×4
Damper cap
210005



避震器下座 ×4
Damper retainer
210005

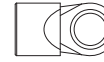

避震器下拉桿頭 ×4
Damper adjuster
210005

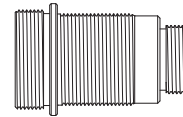

鋁合金避震器筒身 ×4
Alum. damper cylinder
210151

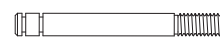

避震軸心 ×4
Piston rod
310008

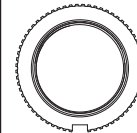

避震器調整環 ×4
Spring retainer
310004R (red / 紅) /
310004S (silver / 銀)

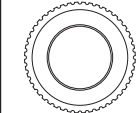

避震器上蓋 ×4
Cylinder cap
310003R (red / 紅) /
310003S (silver / 銀)



避震器下蓋 ×4
Rod guide cap
310005R (red / 紅) /
310005S (silver / 銀)



6.5X2 泡棉 ×5
6.5x2 sponge
130021



下蓋墊片 ×4
Rod guide
210235



避震活塞 ×4
Piston
210235

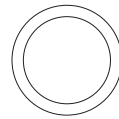

11.5×11.5 O形環 ×4
O-ring
130002



避震氣室 ×4
Oil seal
130004



阻尼器O環 P3 (藍) (10) ×4
Damper O-ring P3 (blue) (10)
130028



2.0 E形扣 ×8
E-clip
110013

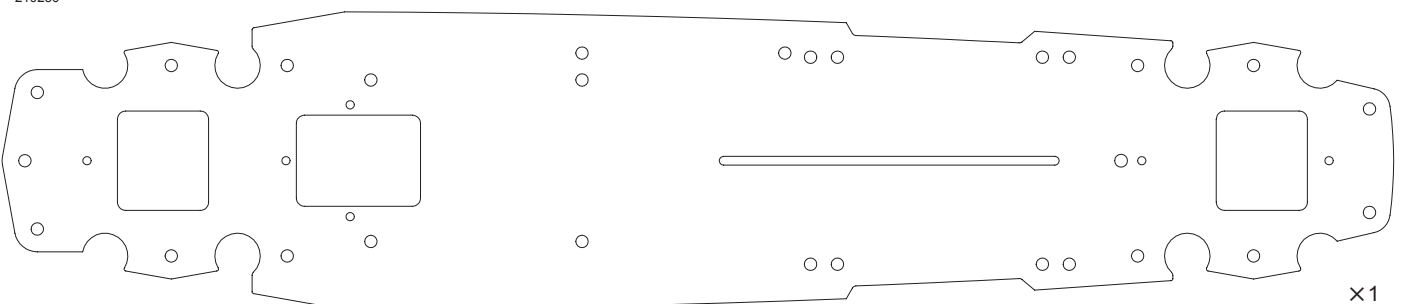

×1

PARTS



M3×12 半圓頭螺絲 ×1
Screw
110029



M2.5×14 半圓頭螺絲 ×2
Screw
110010



M3×10 半圓頭螺絲 ×5
Screw
110026



M2.6×10 半圓頭自攻螺絲 ×1
Screw
110025



M3×8 半圓頭螺絲 ×6
Screw
110002



M2.5×6 半圓頭螺絲 ×14
Screw
110003



M3×6 半圓頭螺絲 ×29
Screw
110001



M2×4 半圓頭螺絲 ×4
Screw
110004



M3×8 沉頭螺絲 ×23
Screw
110005



2×11.8 插銷 ×6
Shaft
110019



M3×6 沉頭螺絲 ×3
Screw
110024

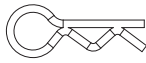

R6 R形扣 ×5
R-clip
110016



M3×20 止付螺絲 ×2
Screw
110009



M4 凸緣螺帽 ×4
Flange nut
110015



M3×16 止付螺絲 ×2
Screw
110023



M3 防鬆螺帽 ×1
Lock nut
110021



M3×10 止付螺絲 ×3
Screw
110032



5×8 培林 ×4
Ball bearing
120003



M3×6 止付螺絲 ×4
Screw
110007



5×11 培林 ×4
Ball bearing
120011

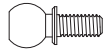

5.8×6 球頭 ×8
Ball connector
210160



5×10 培林 ×3
Ball bearing
120002



5.8×4 球頭 ×8
Ball connector
210159



3×6 凸緣培林 ×2
Flange bearing
120010



4.8×4.5 球頭 ×20
Ball connector
310001

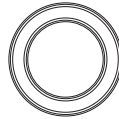

10×15 培林 ×8
Ball bearing
120001



4.8 外六角球頭螺帽 ×6
Ball connector nut
210161

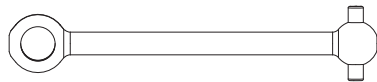

鋼製 CVD 傳動軸 42 ×4
Steel CVD universal shaft 42
820004



連接軸 ×4
Cross joint
820030

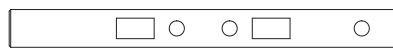

主齒軸 ×1
Direct center shaft
310009

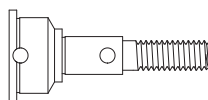

萬向接杯 ×4
Wheel axle
310006

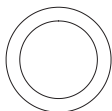

8.5×1.5 O環 ×1
O-ring
210124-1

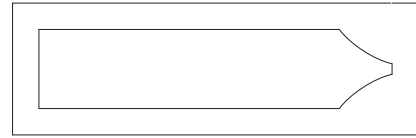

黑色油膏 ×1
Black grease
130008

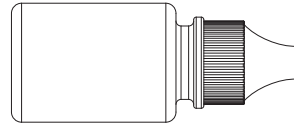

避震油 #300 ×1
Damper oil #300
130009

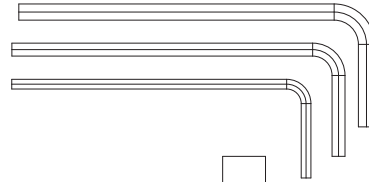

工具包 ×1
Tools
130011



鋁合金拉桿扳手4mm ×1
Alum. turnbuckle wrench 4mm
210272



天線管 ×1
Antenna pipe
130007

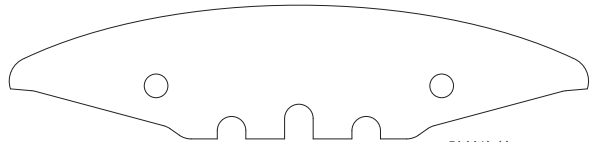

防撞泡棉 ×1
Bumper
130005

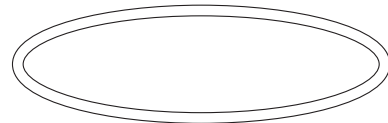

44×2.6mm O形環 ×2
O-ring
130003

210144 ×1
避震彈簧28mm
Coil spring set 28mm

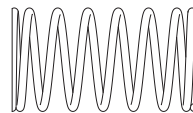

避震彈簧28mm (銀/硬) ×2
Coil spring 28mm (silver / stiff)
210144-1

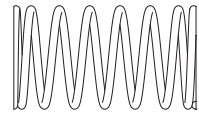

避震彈簧28mm (金/中) ×2
Coil spring 28mm (gold / medium)
210144-2



避震彈簧28mm (紅/軟) ×2
Coil spring 28mm (red / soft)
210144-3

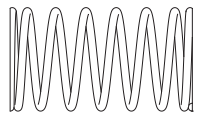

避震彈簧28mm (白/超軟) ×2
Coil spring 28mm (white / super soft)
210144-4

PARTS

210102R (red / 紅) / 210102S (silver / 銀) × 1set
 鋁合金單向組
 Alum. one way unit

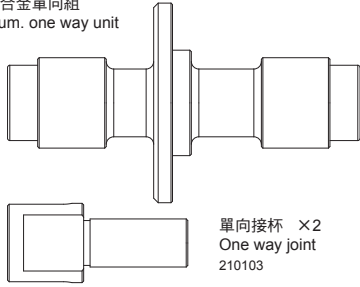

單向接杯 × 2
 One way joint
 210103

210122R (red / 紅) / 210122S (silver / 銀) × 1set
 鋁合金轉向雙搖臂組
 Alum. steering arm

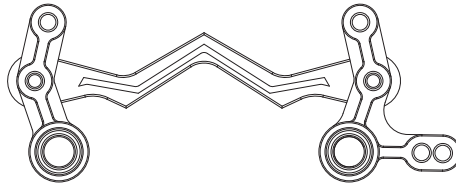

210143 × 1set
 鋁合金六角輪座 (煞車碟型)
 Alum. wheel hubs (brake disc shaped)

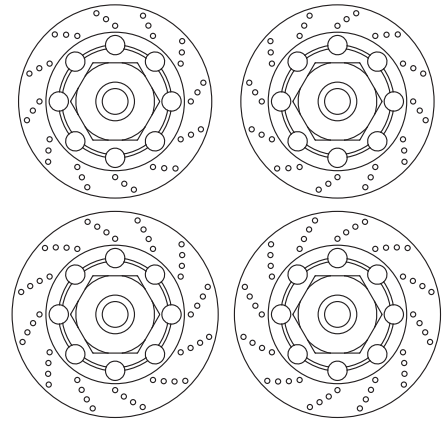

3.5×1 O形環 × 4
 O-ring
 130015

210121 × 1set
 鋁合金直軸組
 Alum. spool unit

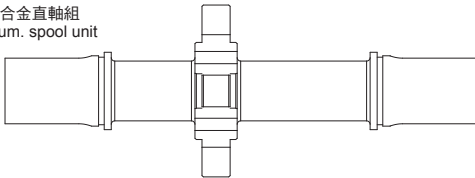

馬蹄扣 × 2
 Swing shaft protector
 210121-1

210136R (red / 紅) / 210136S (silver / 銀) × 2
 鋁合金側板組
 Alum. bulkhead

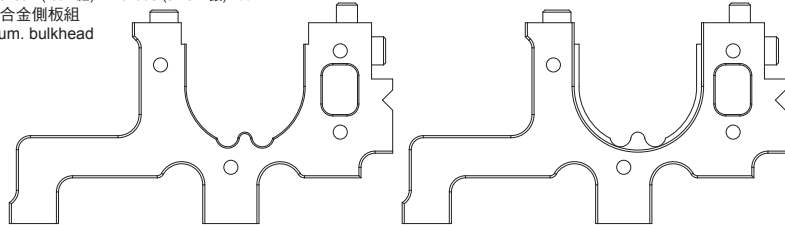

210134R (red / 紅) / 210134S (silver / 銀) × 2
 鋁合金側板上蓋組
 Alum. upper bulkhead

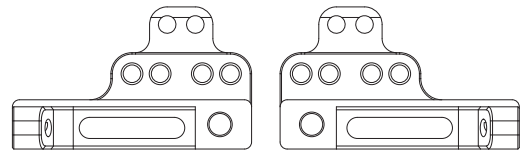

210135R (red / 紅) / 210135S (silver / 銀) × 1
 鋁合金主軸座
 Alum. main shaft mount

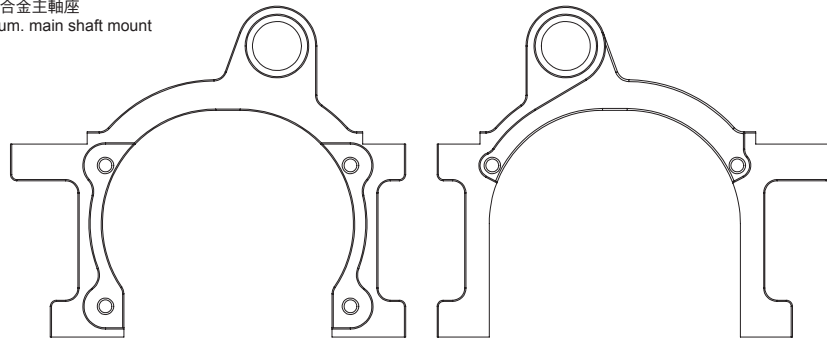

鋁製可調拉桿3×60mm × 1
 Alum. turnbuckle 3×60mm
 210105R (red / 紅) /
 210105S (silver / 銀)

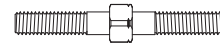

鋁製可調拉桿3×28mm × 2
 Alum. turnbuckle 3×28mm
 210108R (red / 紅) /
 210108S (silver / 銀)

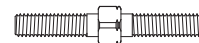

鋼製可調拉桿3×25mm × 2
 Steel turnbuckle 3×25mm
 210168R (red / 紅) /
 210168S (silver / 銀)

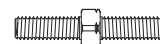

鋼製可調拉桿3×20mm × 2
 Steel turnbuckle 3×20mm
 210166R (red / 紅) /
 210166S (silver / 銀)



鋁製可調拉桿3×20mm × 2
 Alum. turnbuckle 3×20mm
 210165R (red / 紅) /
 210165S (silver / 銀)

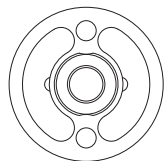

鋁合金主齒固定座 × 1
 Alum. spur gear holder
 210117R (red / 紅) /
 210117S (silver / 銀)



鋁合金主齒固定板 × 1
 Alum. spur gear holder cover
 210116R (red / 紅) /
 210116S (silver / 銀)

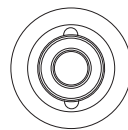

鋁合金皮帶壓輪 × 1
 Alum. belt pulley
 210124



鋁合金前防撞板上蓋 × 1
 Alum. bumper support
 210142R (red / 紅) /
 210142S (silver / 銀)

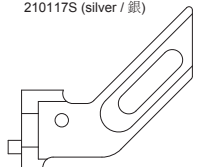

鋁合金後可調皮帶壓輪座 × 1
 Alum. belt stabilizer mount
 210123R (red / 紅) /
 210123S (silver / 銀)

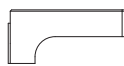

鋁合金伺服機座 × 2
 Alum. servo mount
 210101R (red / 紅) /
 210101S (silver / 銀)

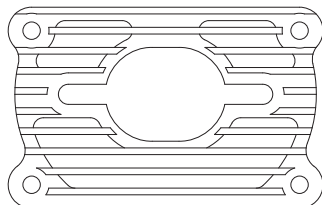

鋁合金馬達散熱座 × 1
 Alum. motor heat sink mount
 210114R (red / 紅) /
 210114S (silver / 銀)



轉向支柱 × 2
 Alum. steering post
 210183R (red / 紅) /
 210183S (silver / 銀)



壓輪培林座 × 1
 Belt pulley mount
 210123R (red / 紅) /
 210123S (silver / 銀)

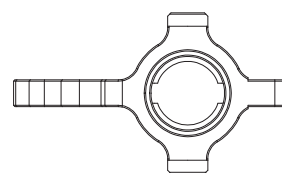

鋁合金轉向輪座 × 2
 Alum. upright
 210118R (red / 紅) /
 210118S (silver / 銀)

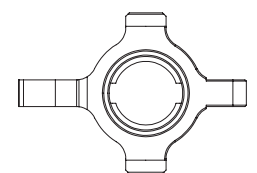

鋁合金前轉向座 × 2
 Alum. front upright
 210239R (red / 紅) /
 210239S (silver / 銀)



3×5.5×2mm 鋁墊片 × 4
 Alum. spacer
 820027R (red / 紅) /
 820027S (silver / 銀)



3×5.5×1mm 鋁墊片 × 2
 Alum. spacer
 820026R (red / 紅) /
 820026S (silver / 銀)

